



Project:

Item Number:

Quantity:

**AFFORDABLE PORTABLE™ REFRIGERATED COLD FOOD STATIONS**



**FEATURES & BENEFITS**

- Station is constructed of vinyl-clad, 20-gauge carbon steel.
- R513A refrigerant is non-flammable and has low-global-warming-potential (GWP).
- Foamed-in-place polyurethane insulation provides efficiency and performance.
- NSF2 buffet or NSF2 cafeteria-style acrylic breath guard protects food from germs.
- Five color options fit well with any design aesthetic.
- 1" (2.54 cm) integral drain makes cleanup easy.
- 8 ft (2.4 m) cord with plug allows placement options.
- Casters lock to ensure stability.

**WARRANTY**

All models shown come with Vollrath's standard warranty against defects in materials and workmanship, with an additional four years on the compressor. For full warranty details, please refer to [vollrathfoodservice.com](http://vollrathfoodservice.com).

**AGENCY LISTING**



Due to continued product improvement, please consult [vollrathfoodservice.com](http://vollrathfoodservice.com) for current product specifications.

Approvals	Date

**ITEMS**

Description 120V	Solid Base		Solid Base w/ Lights		Open Storage Base		Open Storage w/ Lights		Storage Base w/ Door		Storage Base w/ Door & Lights	
	Buffet	Cafeteria	Buffet	Cafeteria	Buffet	Cafeteria	Buffet	Cafeteria	Buffet	Cafeteria	Buffet	Cafeteria
With NSF2 Breath Guard												
Black												
3-Pan 46"	R38713	R39713	R3871346	n/a	R38714	R39714	R3871446	n/a	R38715	R39715	R3871546	n/a
4-Pan 60"	R38716	R39716	R3871660	n/a	R38717	R39717	R3871760	n/a	R38718	R39718	R3871860	n/a
Walnut Grain												
3-Pan 46"	R38950	R39950	R3895046	n/a	R38951	R39951	R3895146	n/a	R38952	R39952	R3895246	n/a
4-Pan 60"	R38960	R39959	R3896060	n/a	R38961	R39961	R3896160	n/a	R38962	R39962	R3896260	n/a
Cherry Grain												
3-Pan 46"	R38773	R39773	R3877346	n/a	R38774	R39774	R3877546	n/a	R38775	R39775	R3877546	n/a
4-Pan 60"	R38776	R39776	R3877660	n/a	R38777	39777	R3877860	n/a	R38778	R39778	R3877860	n/a
Granite												
3-Pan 46"	R38733	R39733	R3873346	n/a	R38734	R39734	R3873446	n/a	R38735	R39735	R3873546	n/a
4-Pan 60"	R38736	R39736	R3873660	n/a	R38737	R39737	R3873760	n/a	R38738	R39738	R3873860	n/a
Brushed Aluminum												
3-Pan 46"	R38733A	R39733A	R3873346A	n/a	R38734A	R39734A	R3873446A	n/a	R38735A	R39735A	R3873546A	n/a
4-Pan 60"	R38736A	R39736A	R3873660A	n/a	R38737A	R39737A	R3873760A	n/a	R38738A	R39738A	R3873860A	n/a

# AFFORDABLE PORTABLE™ REFRIGERATED COLD FOOD STATIONS

## DIMENSIONS — Shown in inches (cm)

3-Pan Refrigerated Cold Station with NSF2 Cafeteria Breath Guard

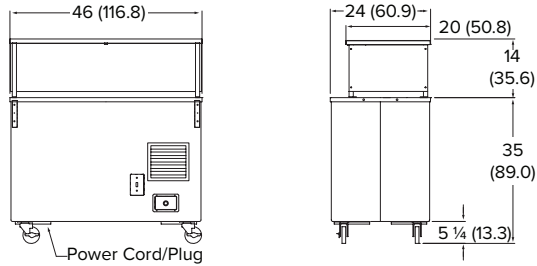

4-Pan Refrigerated Cold Station with NSF2 Cafeteria Breath Guard

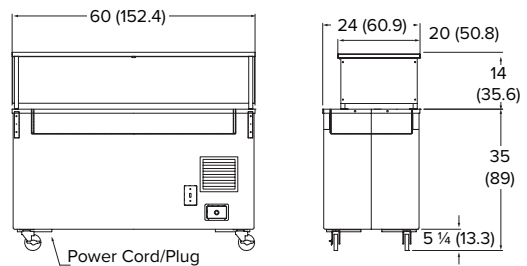

3-Pan Refrigerated Cold Station with NSF2 Buffet Breath Guard

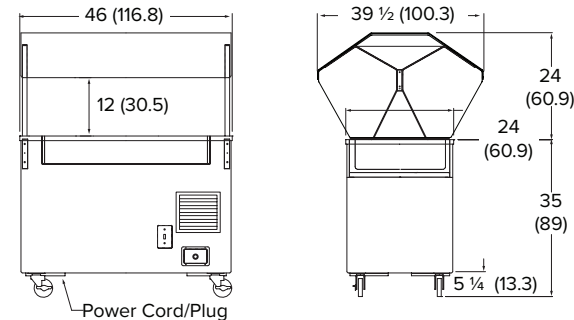

4-Pan Refrigerated Cold Station with NSF2 Buffet Breath Guard

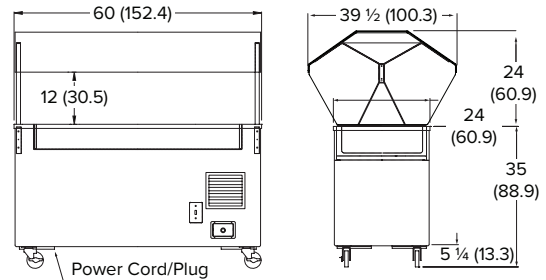



3-Well Storage Opening: 24 X 23 X 16 1/2 (61 x58 x 42)

4-Well Storage Opening: 36 X 23 X 16 1/2 (91.59 x58 x 42)

**NOTICE: A minimum of 3" clearance in front of vents is required for unobstructed airflow. For best performance, prevent drafts and air currents from passing over the display surface.**

## ACCESSORIES

Item	300 Series Stainless Steel	Stainless Steel	Poly-ethylene	Fold-Down Mounting Brackets	Depth Inches (cm)	Added Depth when Folded	24" (61 cm) Item #	46" (117 cm) Item #	60" (152 cm) Item #	Add NF Before Item # for non-folding	White Item #	Red Item #
Tray Slides with 11" (27.9) tray area 	X	--	--	X	11 1/2 (29.2)	5 1/2 (14)	39924	39946	39960	X	--	--
Cutting Boards 	--	--	X	X	7 (17.8)	4 (10.2)	39824	39846	39860	--	--	--
Plate Rests 	--	X	--	X	7 (17.8)	4 1/2 (11.4)	38992	38993	38994	X	--	--
Infrared Lamp Bulbs, 250W (12)	--	--	--	--	--	--	--	--	--	--	72442	72441

## SPECIFICATIONS

Item	Clearance	HP	Peak Heat of Rej. (BTUH)	Amp	Refrig. Charge	V	Plug	Recept-acle
3-Pan	3" (7.6 CM) min. clearance in front of vents for unobstructed airflow	1/5	2800	3.6	6 oz	120	NEMA 5-15P	
3-Pan w/Lights*				4.2				
4-Pan		1/3	4800	7.1				
4-Pan w/Lights*				8.4				

\*Incandescent lamps (40W maximum per fixture)



The Vollrath Company, L.L.C.  
 1236 North 18th Street  
 Sheboygan, WI 53081-3201 U.S.A.  
 Main Tel: 800.624.2051 or 920.457.4851  
 Main Fax: 800.752.5620 or 920.459.6573  
 Customer Service: 800.628.0830  
 Canada Customer Service: 800.695.8560

Technical Services  
 techservicereps@vollrathco.com  
 Induction: 800.825.6036  
 Countertop Warming: 800.354.1970  
 Other Products: 800.628.0832